

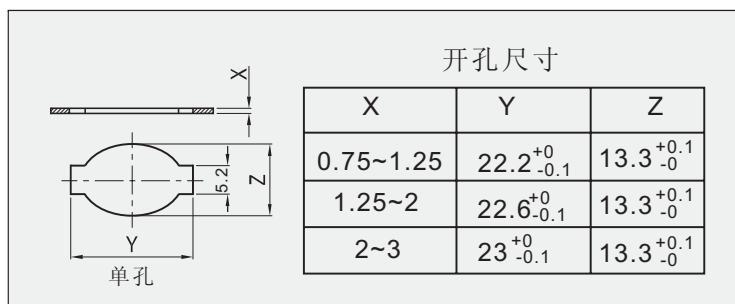

SC760-6VAH-20G

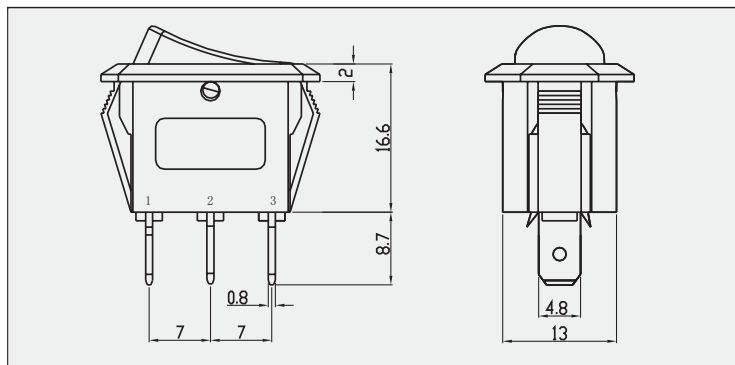

◆ 产品特点

- 切换手感好，触头分断迅速
- 进口材质的琴钢线弹簧可以提供足够的接触压力和保证产品的机械寿命
- 外观独特
- 广泛用于台灯、咖啡机、搅拌机、电暖器等各类电器





◆ 技术参数

电气参数	6A 125VAC 3A 250VAC 10(3)A 250VAC T90/55 1E4
电气寿命	1E4
机械寿命	5E4
接触电阻	≤20mΩ
绝缘阻抗	>100MΩ
耐电压	1500VAC
耐漏电起痕指数	PTI 175
触点间距	>3mm
防护等级	IP20
周围空气温度	0度...+90度
防火等级	UL94V-0
灼热丝温度	850℃
基座和按钮材质	尼龙/聚碳酸酯
触点材质	银 或 银氧化镉
端子材质	铜合金
端子温升	小于.30度 (UL1054) 小于.55度 (EN61058-1)
端子插拔力	≥80牛顿
安规标志	
本开关适用于II类器具	

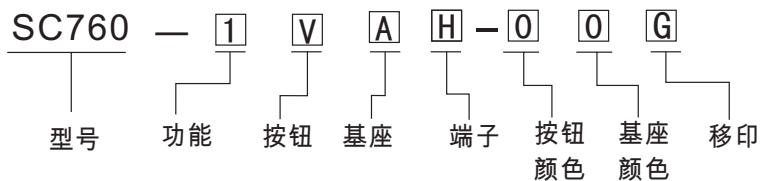
SC760 单排跷板开关系列



◆ 产品型号



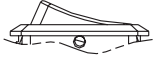

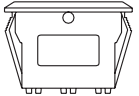
功能(1)	
功能	电路
开-关	 1
开-开	 2
开-关-开	 3
开-关 带灯	 6





按钮(2)		
按钮形状	代码	示意图
弧形按钮	V	

基座(3)	
示意图	
	A

端子(4)	
端子	示意图
快插端子 4.8X0.8mm	 H
焊锡端子	 C

按钮移印(5)				
示意图	代码	代码	示意图	
	G	ON OFF	R	
	P		Q	

常用产品型号描述范例

产品型号	电路图	功能	端子类型	按钮/基座颜色	移印
SC760-1VAC-00G		开-关	焊锡端子	黑色/黑色	
SC760-6VAH-20P		开-关 带灯	快插端子 4.8X0.8mm	红色/黑色	
SC760-3VAH-00Q		开-关-开	快插端子 4.8X0.8mm	黑色/黑色	